

Low forward voltage Transil™, transient voltage suppressor

Features

- Low forward voltage: 1.05 V @ 850 mA
- Peak pulse power (8/20 μs): 350 W
- Very low clamping factor V_{CL}/V_{BR}
- Unidirectional device
- Fast response time
- Very thin package: 0.605 mm
- RoHS compliant

Complies with the following standards:

- IEC 61000-4-2 level 4
 - ± 15 kV (air discharge)
 - ± 8 kV (contact discharge)

Description

The LFTVS7-1F3 is a single line diode designed specifically for the protection of integrated circuits in portable equipment and miniaturized electronics devices subject to ESD and EOS transient overvoltages.

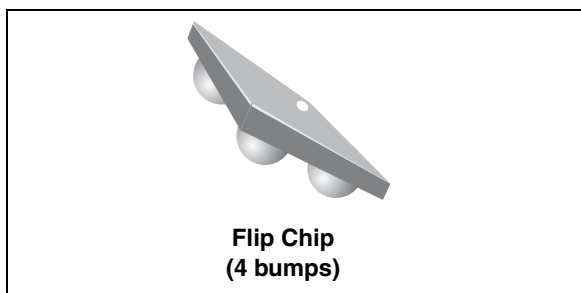

Figure 1. Pin configuration (bump side)

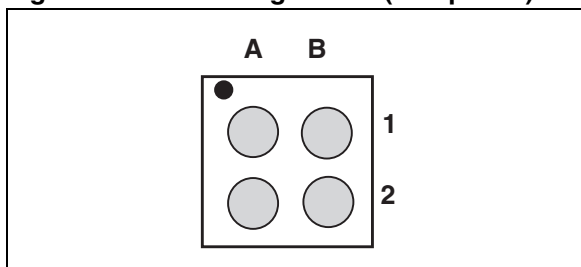
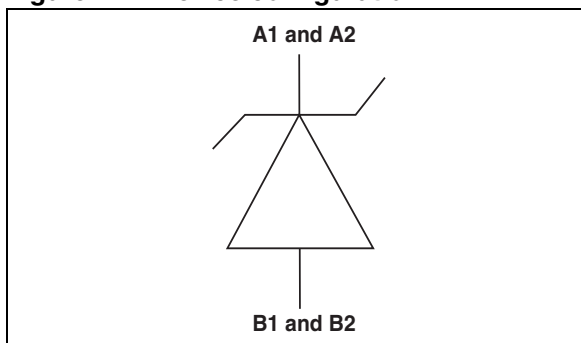

Figure 2. Device configuration



TM: Transil is a trademark of STMicroelectronics

1 Characteristics

Table 1. Absolute maximum ratings ($T_{amb} = 25\text{ }^{\circ}\text{C}$)

Symbol	Parameter	Test condition	Value	Unit
P_{PP}	Peak pulse power dissipation (10/1000 μs pulse)	$T_j \text{ initial} = T_{amb}$	75	W
	Peak pulse power dissipation (8/20 μs pulse)		350	
I_{FSM}	Non repetitive surge peak forward current	$t_p = 10\text{ ms}$ $T_j \text{ initial} = T_{amb}$	11	A
T_j	Maximum operating junction temperature		125	$^{\circ}\text{C}$
T_{stg}	Storage temperature range		-55 to +150	$^{\circ}\text{C}$

Table 2. Electrical characteristics ($T_{amb} = 25\text{ }^{\circ}\text{C}$)

Symbol	Parameter								
V_{BR}	Breakdown voltage								
I_{RM}	Leakage current @ V_{RM}								
V_{RM}	Stand-off voltage								
V_{CL}	Clamping voltage								
R_d	Dynamic impedance								
I_{PP}	Peak pulse current								
αT	Voltage temperature coefficient								
V_F	Forward voltage drop								
Symbol	Test conditions					Min.	Typ.	Max.	Unit
V_{BR}	$I_R = 15\text{ mA}$					7			V
I_{RM}	$V_{RM} = 5.5\text{ V}$			500	nA				
V_{CL}	$I_{PP} = 1\text{ A}^{(1)}$			10	V				
V_F	$I_F = 850\text{ mA}$			1.05	V				
αT				6	$10^{-4}/^{\circ}\text{C}$				
C_{line}	$V_R = 0\text{ V}, V_{OSC} = 30\text{ mV}, F = 1\text{ MHz}$		320		pF				

1. 8 / 20 μs pulse waveform

Figure 3. Relative variation of peak pulse power versus initial junction temperature

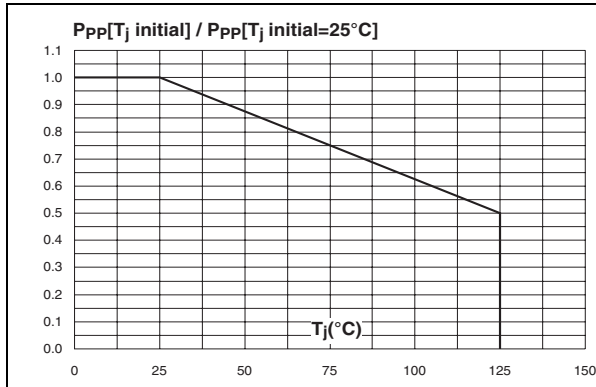

Figure 4. Peak pulse power versus exponential pulse duration (typical value)

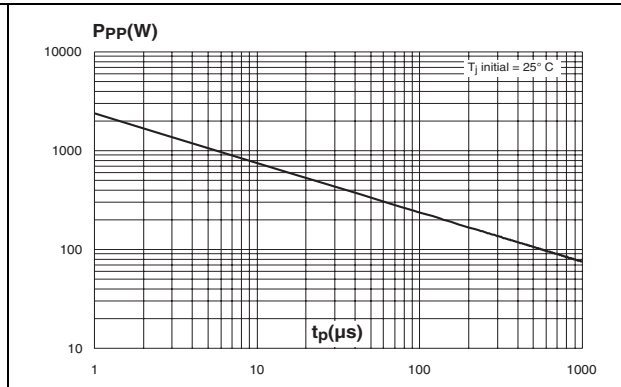

Figure 5. Clamping voltage versus peak pulse current (typical values)

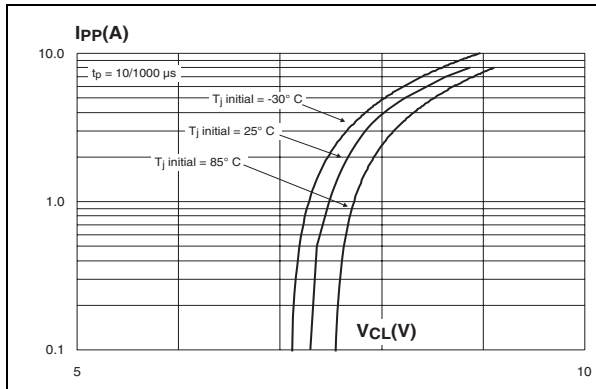

Figure 6. Relative variation of leakage current versus junction temperature (typical values)

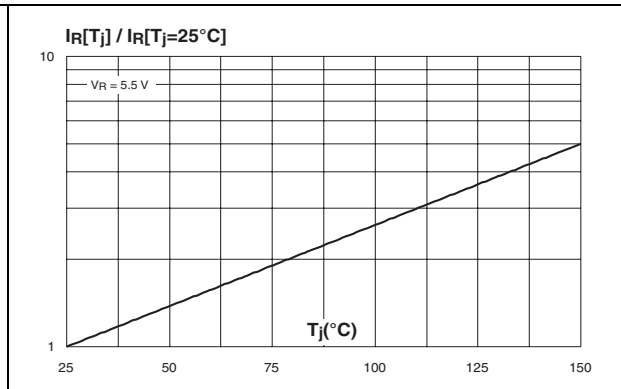

Figure 7. Forward voltage drop versus peak forward current (typical values)

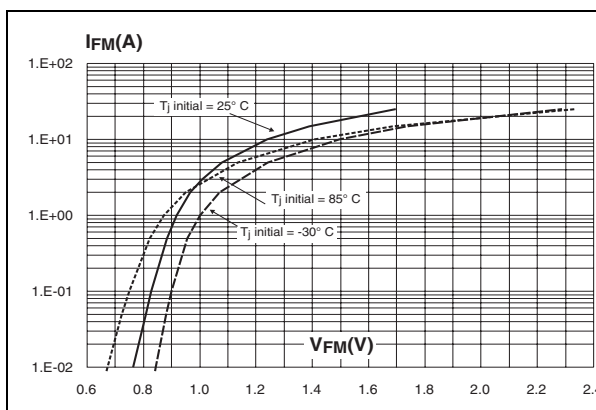

Figure 8. Junction capacitance versus reverse voltage applied (typical values)

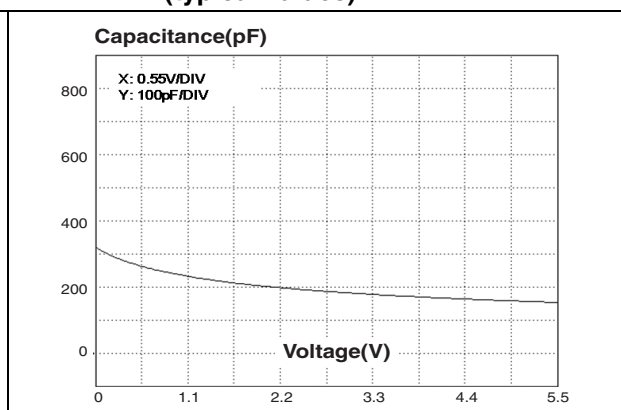

Figure 9. Breakdown voltage versus initial junction temperature (typical value)

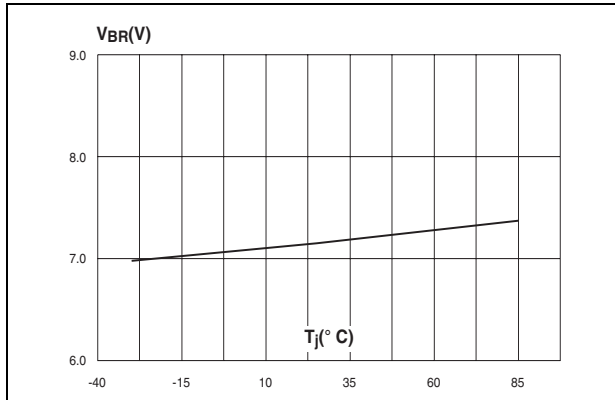

Figure 10. Frequency response

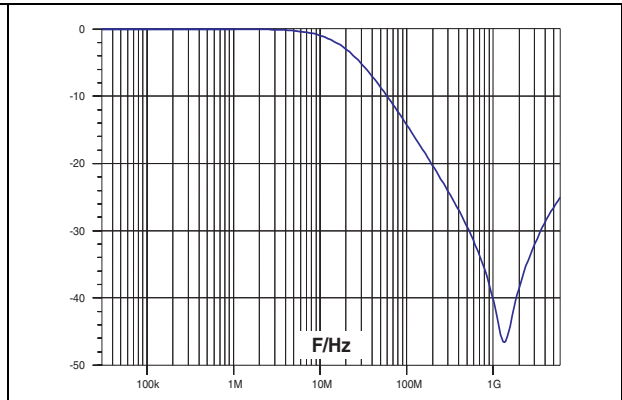

Figure 11. ESD response to IEC 61000-4-2 (+8 kV contact discharge)

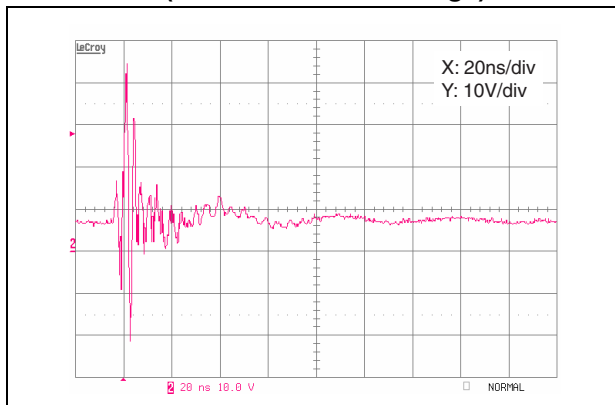
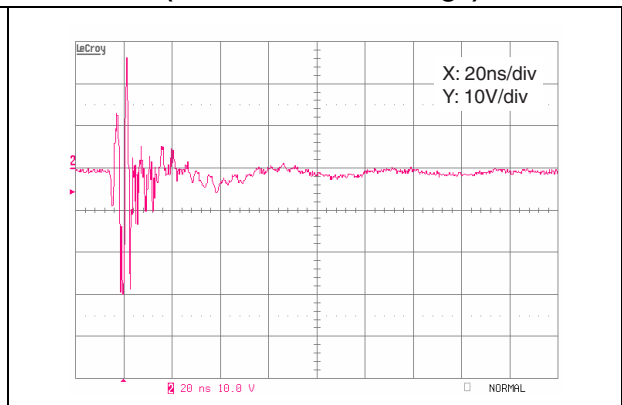
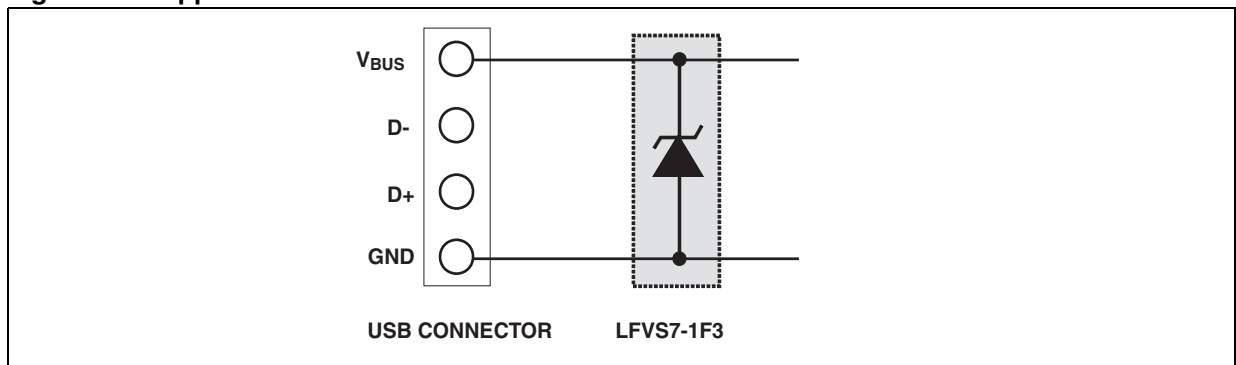

Figure 12. ESD response to IEC 61000-4-2 (-8 kV contact discharge)



2 Application information

Figure 13. Application schematic



3 Ordering information scheme

Figure 14. Ordering information scheme

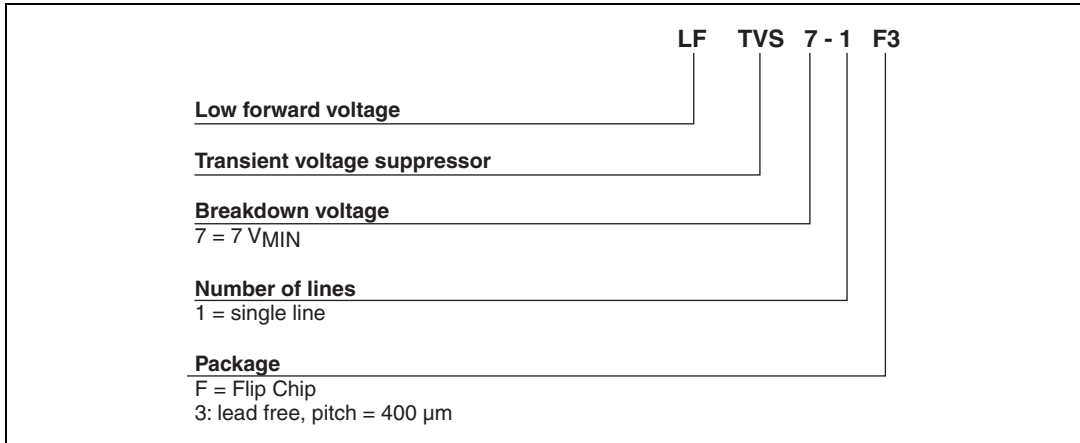

4 Package information

In order to meet environmental requirements, ST offers these devices in ECOPACK[®] packages. These packages have a lead-free second level interconnect. The category of second level interconnect is marked on the inner box label, in compliance with JEDEC Standard JESD97. The maximum ratings related to soldering conditions are also marked on the inner box label. ECOPACK is an ST trademark. ECOPACK specifications are available at www.st.com.

Figure 15. Flip Chip dimensions

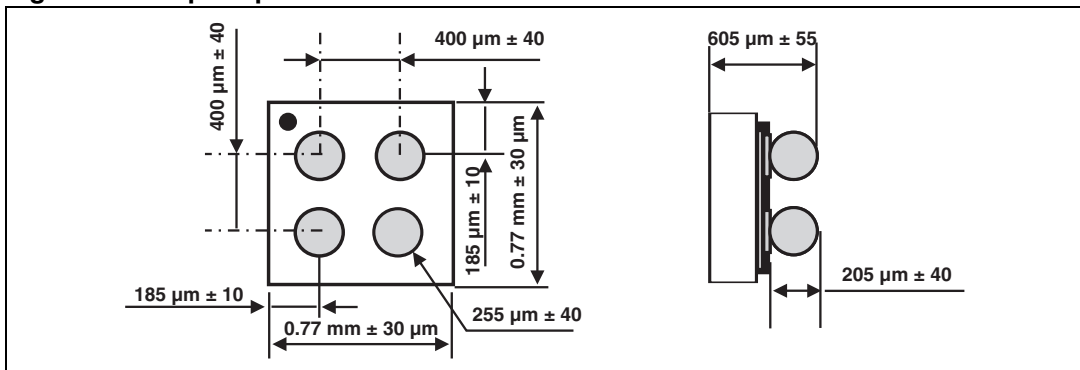

Figure 16. Foot print recommendations **Figure 17. Marking**

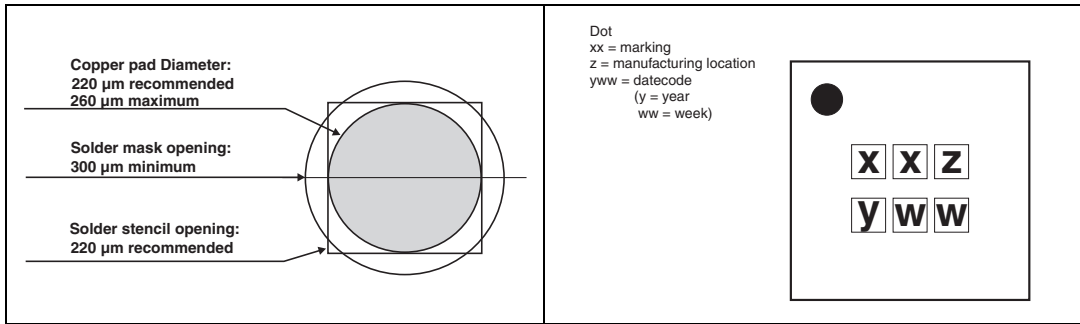
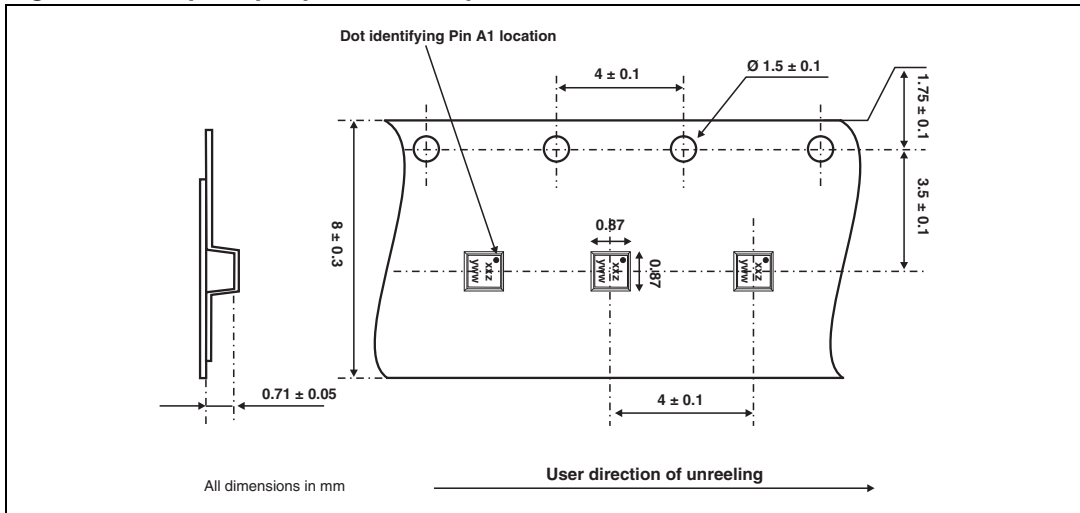

Figure 18. Flip Chip tape and reel specifications



Note: More information is available in the application notes:
 AN2348: "400 μm Flip Chip: Package description and recommendations for use"
 AN1751: "EMI Filters: Recommendations and measurements"

5 Ordering information

Table 3. Ordering information

Order code	Marking	Package	Weight	Base qty	Delivery mode
LFTVS7-1F3	EJ	Flip Chip	0.86 mg	5000	Tape and reel (7")

6 Revision history

Table 4. Document revision history

Date	Revision	Changes
01-Mar-2007	1	Initial release.
16-Apr-2008	2	Updated ECOPACK statement. Updated Figure 14 , and Figure 15 . Reformatted to current standards. Changed V_F from 1.2 to 1.05 V.

Please Read Carefully:

Information in this document is provided solely in connection with ST products. STMicroelectronics NV and its subsidiaries ("ST") reserve the right to make changes, corrections, modifications or improvements, to this document, and the products and services described herein at any time, without notice.

All ST products are sold pursuant to ST's terms and conditions of sale.

Purchasers are solely responsible for the choice, selection and use of the ST products and services described herein, and ST assumes no liability whatsoever relating to the choice, selection or use of the ST products and services described herein.

No license, express or implied, by estoppel or otherwise, to any intellectual property rights is granted under this document. If any part of this document refers to any third party products or services it shall not be deemed a license grant by ST for the use of such third party products or services, or any intellectual property contained therein or considered as a warranty covering the use in any manner whatsoever of such third party products or services or any intellectual property contained therein.

UNLESS OTHERWISE SET FORTH IN ST'S TERMS AND CONDITIONS OF SALE ST DISCLAIMS ANY EXPRESS OR IMPLIED WARRANTY WITH RESPECT TO THE USE AND/OR SALE OF ST PRODUCTS INCLUDING WITHOUT LIMITATION IMPLIED WARRANTIES OF MERCHANTABILITY, FITNESS FOR A PARTICULAR PURPOSE (AND THEIR EQUIVALENTS UNDER THE LAWS OF ANY JURISDICTION), OR INFRINGEMENT OF ANY PATENT, COPYRIGHT OR OTHER INTELLECTUAL PROPERTY RIGHT.

UNLESS EXPRESSLY APPROVED IN WRITING BY AN AUTHORIZED ST REPRESENTATIVE, ST PRODUCTS ARE NOT RECOMMENDED, AUTHORIZED OR WARRANTED FOR USE IN MILITARY, AIR CRAFT, SPACE, LIFE SAVING, OR LIFE SUSTAINING APPLICATIONS, NOR IN PRODUCTS OR SYSTEMS WHERE FAILURE OR MALFUNCTION MAY RESULT IN PERSONAL INJURY, DEATH, OR SEVERE PROPERTY OR ENVIRONMENTAL DAMAGE. ST PRODUCTS WHICH ARE NOT SPECIFIED AS "AUTOMOTIVE GRADE" MAY ONLY BE USED IN AUTOMOTIVE APPLICATIONS AT USER'S OWN RISK.

Resale of ST products with provisions different from the statements and/or technical features set forth in this document shall immediately void any warranty granted by ST for the ST product or service described herein and shall not create or extend in any manner whatsoever, any liability of ST.

ST and the ST logo are trademarks or registered trademarks of ST in various countries.

Information in this document supersedes and replaces all information previously supplied.

The ST logo is a registered trademark of STMicroelectronics. All other names are the property of their respective owners.

© 2008 STMicroelectronics - All rights reserved

STMicroelectronics group of companies

Australia - Belgium - Brazil - Canada - China - Czech Republic - Finland - France - Germany - Hong Kong - India - Israel - Italy - Japan - Malaysia - Malta - Morocco - Singapore - Spain - Sweden - Switzerland - United Kingdom - United States of America

www.st.com